

QN ATTENUATOR

5 DB 3 GHZ 1W

R412.305.124

Series : ATTENUATOR

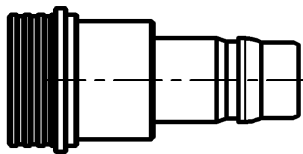
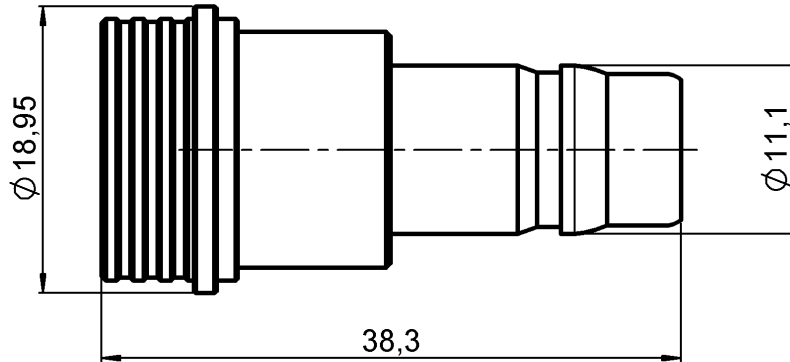

Ech : 1

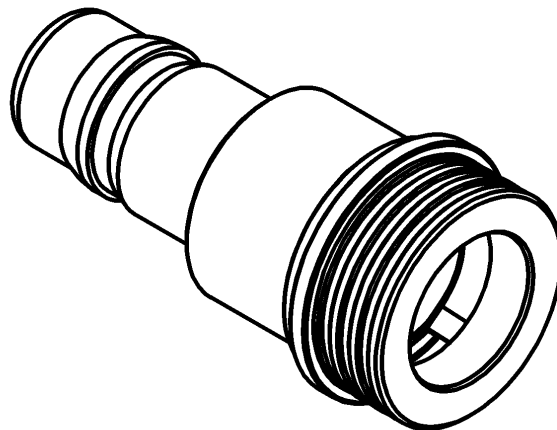

All dimensions are in mm.

COMPONENTS	MATERIALS	PLATING(μm)
BODY	BRASS	BBR 0.5 OVER SILVER 3
MALE CENTER CONTACT	BRASS	GOLD 1.3 OVER COPPER 2.5
FEMALE CENTER CONTACT	BERYLLIUM COPPER	GOLD 1.3 OVER COPPER 2.5
OUTER CONTACT	BERYLLIUM COPPER	Teccoat 602-03
INSULATOR	PTFE	
GASKET	EPDM	
SUBSTRATE	ALUMINA	
RESISTOR	THICK FILM	
OTHERS PARTS		

Issue : 0404 A

In the effort to improve our products, we reserve the right to make changes judged to be necessary.

QN ATTENUATOR

5 DB 3 GHZ 1W

R412.305.124

Series : ATTENUATOR

ELECTRICAL CHARACTERISTICS

Frequency (GHz)	2	2 - 3
V.S.W.R (≤)	1.20	1.30
Deviation(±dB)	0.30	0.50

Operating Frequency Range	DC - 3	GHz
Impedance	50	Ω
Nominal Attenuation	5	dB
Peak power at 25°C (1μs, 1%)	100	W
Average power at 25°C	1	W (Free Air Cooled)

MECHANICAL CHARACTERISTICS

Connectors	QN	Male Female
Weight	28.380	g

ENVIRONMENTAL CHARACTERISTICS

Operating temperature range	-40 / +85 °C
Storage temperature range	-40 / +85 °C

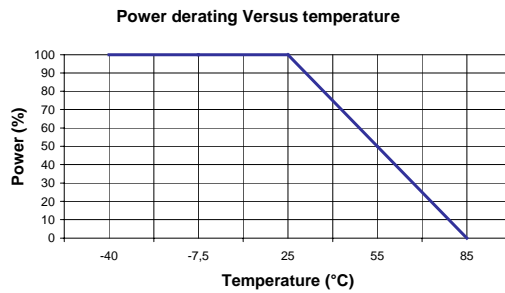

SPECIFICATION

OTHER CHARACTERISTICS

Mating Life : 100 Cycles

Issue : 0404 A

In the effort to improve our products, we reserve the right to make changes judged to be necessary.